



Dependable Products From People You Trust



Recording Atmospheric Consistometer

#120-80: 115 VAC

#120-80-1: 220 VAC

Instruction Manual

Updated 10/23/2025

Ver. 1

OFI Testing Equipment, Inc.

11302 Steeplecrest Dr. · Houston, Texas · 77065 · U.S.A.

Tele: 832.320.7300 · Fax: 713.880.9886 · www.ofite.com

©Copyright OFITE 2025

Table of Contents

Intro.....	2
Description.....	2
Features.....	2
Requirements	2
Components	3
Setup.....	5
Loading the Test Cells	7
Onboard Display.....	8
<i>Real-Time Data</i>	<i>9</i>
<i>Utilities.....</i>	<i>10</i>
<i>Archive</i>	<i>11</i>
<i>Graphs</i>	<i>12</i>
Operation.....	13
Calibration.....	14
<i>Potentiometer.....</i>	<i>14</i>
<i>Temperature Verification</i>	<i>15</i>
<i>Motor Speed</i>	<i>15</i>
<i>Timer</i>	<i>15</i>
Test Setup	16
Maintenance.....	18
Warranty and Return Policy	20

Intro

The Model 80 Recording Atmospheric Consistometer is designed to condition cement slurries according to API Specification 10. Determination of rheological properties, examination of free water content, and evaluation of the API fluid loss test all require that the cement slurry be conditioned by an atmospheric consistometer. The OFITE Model 80 was specifically developed to perform these duties.

Description

A cement slurry is prepared according to the procedure outlined in API Specification 10 and then placed in the slurry container. The slurry is stirred at 150 RPM by an API-designed paddle assembly. The temperature is controlled by a touchscreen display, which shows temperature and consistency. Consistency, measured in Bearden Units of Consistency, is determined by measuring the deflection of a calibrated spring. This deflection is created by the amount of torque that the cement slurry exerts on the paddle, which is a function of the consistency of the cement. The API defines 100 Bc as 2,080 g-cm of torque.

Features

- Touchscreen display
- Maximum Operating Temperature: 190°F (90°C)
- Operates at atmospheric pressure
- Heat transfer fluid is circulated
- 1,500-Watt Heater
- Slurry container rotational speed is 150 RPM
- Dual sample container design
- Two alarms indicate termination of the test
- Cooling coils
- Stainless steel temperature bath
- Optional deadweight calibration unit
- Size: 14.5" × 15.5" × 24.5" (37 × 39 × 62 cm)
- Weight: 95 lb (43.1 kg)
- Crated Size: 32" × 21" × 32" (81 × 53 × 81 cm)
- Crated Weight: 200 lb (90.7 kg)

Requirements

- Water Supply for Cooling
- Water Drain
- 220 Volt, 50/60 Hz, 2.2 KVA Power Source
- 120 Volt, 50/60 Hz, 4.4 KVA Power Source

Components

#120-001	Mineral Oil, 1 Gallon, Qty: 3
#120-75-8	Motor Timing Pulley
#120-75-19	Paddle Assembly
#120-80-001	Potentiometer Assembly
#120-80-6	Motor
#120-511	Slurry Cup Shear Pin
#121-001	Container O-rings
#121-002	Retaining Ring
#121-007-3	Main Bearing
#121-008	Thermocouple
#121-009	Timing Belt
#121-013	Slurry Container
#121-014	Container Bottom
#172-24-1	Solid State Relay
#174-14	Motor Controller

For 115 VAC Only:

#120-75-2	Water Solenoid Valve
#121-010	Heater
#122-074-1	Fuse, 5 Amp, 5 mm × 20 mm
#122-078	Fuse, 15 Amp, 5 mm × 20 mm
#152-37-3	AC Power Cord

For 230 VAC Only:

#120-75-3	Water Solenoid Valve
#121-010-1	Heater
#122-073-1	Fuse, 3 Amp, 5 mm × 20 mm
#122-077	Fuse, 10 Amp, 5 mm × 20 mm
#220-15A-EURO	AC Power Cord

Optional:

#120-82 Spare Parts for #120-80:

#120-511 Slurry Cup Shear Pin, Qty: 10
#120-602 Calibration Spring, Qty: 1
#120-604 Potentiometer Resistor, Qty: 4
#120-75-19 Paddle Assembly, Qty: 2
#121-001 Container O-rings, Qty: 8
#121-002 Retaining Ring, Qty: 2
#121-007 Rotator Thrust Bearing, Qty: 2
#121-008 Thermocouple, Qty: 1
#121-009 Timing Belt, Qty: 2
#121-010 Heater, Qty: 1
#121-013 Slurry Container, Qty: 1
#121-014 Container Bottom, Qty: 2
#122-073 Fuse, 2 Amp, 5 mm × 20 mm, Qty: 6
#122-074 Fuse, 4 Amp, 5 mm × 20 mm, Qty: 6
#122-077 Fuse, 10 Amp, 5 mm × 20 mm, Qty: 6

#120-83 Spare Parts for #120-80-1:

#120-511 Slurry Cup Shear Pin, Qty: 10
#120-602 Calibration Spring, Qty: 1
#120-604 Potentiometer Resistor, Qty: 4
#120-75-19 Paddle Assembly, Qty: 2
#121-001 Container O-rings, Qty: 8
#121-002 Retaining Ring, Qty: 2
#121-007 Rotator Thrust Bearing, Qty: 2
#121-008 Thermocouple, Qty: 1
#121-009 Timing Belt, Qty: 2
#121-010-1 Heater, Qty: 1
#121-013 Slurry Container, Qty: 1
#121-014 Container Bottom, Qty: 2
#122-072 Fuse, 1 Amp, 5 mm × 20 mm, Qty: 6
#122-073 Fuse, 2 Amp, 5 mm × 20 mm, Qty: 6
#122-075 Fuse, 7 Amp, 5 mm × 20 mm, Qty: 6

#120-75-30 Calibrator Assembly
#152-55 Bath/Circulator, Refrigerated and Heated, 115 VAC, 60 Hz
#152-55-1 Bath/Circulator, Refrigerated and Heated, 230 VAC, 50 Hz

Setup



Note

1. Carefully remove the unit from the crate and place it close to a water supply and drain.

Coolant Supply and Coolant Drain lines are 1/4" NPT connections. The Coolant Supply port should be connected to a 40 PSI (275.8 kPa) water source.

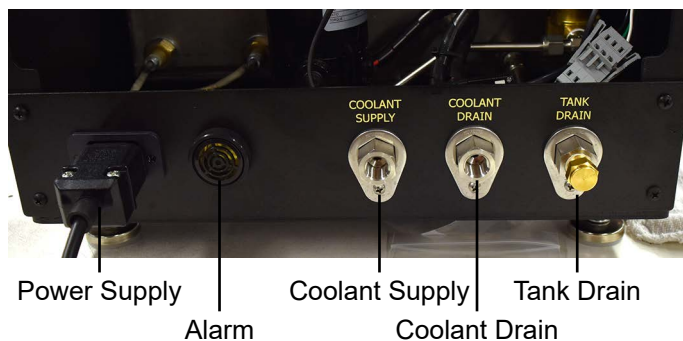

2. Remove both slurry cups. Fill the bath with approximately 2 gallons of mineral oil. Make sure the oil level on the sight glass reaches the red dot.

Do not overfill the bath.

We recommend using only oil in the bath. If you choose to use water, beware of moisture buildup inside the cabinet. Do not turn off the unit while the temperature is above 80°F (27°C). This will allow the fan to remove any water vapor while the bath cools.

3. Connect the unit to a grounded and fused electrical supply.



Important



Important

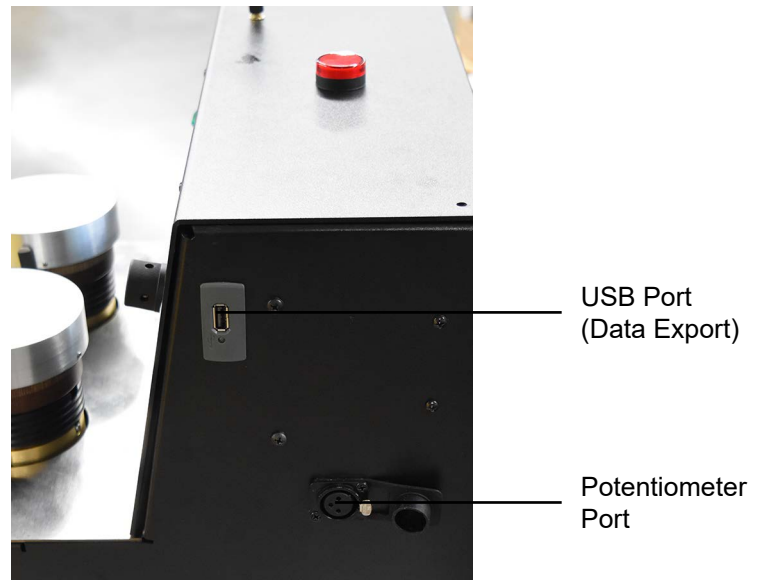

Loading the Test Cells

1. Prepare the cement slurry and pour it into the slurry container as specified in API Specification 10.
2. Insert the paddle into the test cell. Make sure the point on the end of the paddle is inserted into the hole in the bottom of the test cell.
3. Place the lid on the test cell by sliding the torque shaft over the end of the paddle. Turn the lid clockwise until the pin in the torque shaft engages with the slot in the paddle shaft.
4. Continue turning the lid to lock it in place on top of the test cell.
5. Lower the test cell into the bath and lock it in place with the locking pins.
6. Plug the potentiometer into the port on the side of the cabinet.



Note

If the potentiometer is not plugged in, the screen will display and record 0 volts during a test.

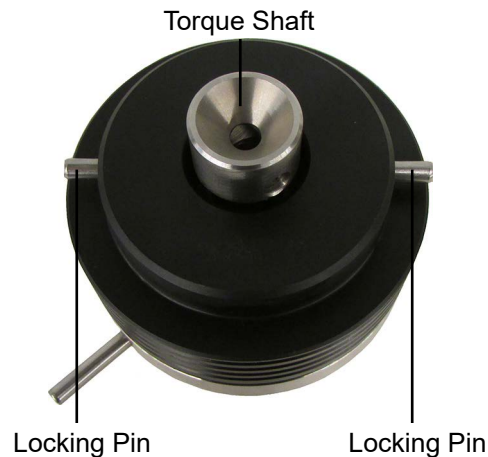

Onboard Display

The Recording Atmospheric Consistometer features an onboard display. It provides access to basic test configuration and control and makes it possible to run tests without an external computer. The display can be operated either as a touchscreen or with the control wheel.

To operate the display with the Control Wheel:

1. Turn the Control Wheel to scroll through the available parameters.
2. Press the Control Wheel to select a parameter.
3. Turn the Control Wheel to scroll through available values for the parameter.
4. Press the Control Wheel to select a value.

If the Atmospheric Consistometer enters an alarm condition, the light on the top of the cabinet will come on and an alarm will sound. To stop the alarm, touch "ACK ALARM".

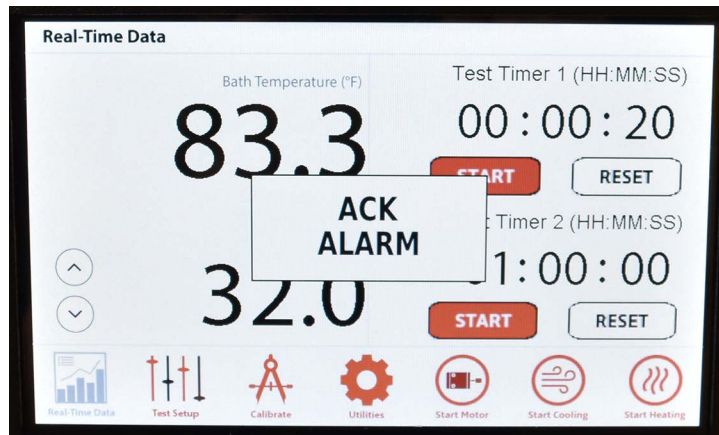

A sensor inside the bath monitors the oil level. If the oil level drops below the thermocouple, the Consistometer can no longer accurately measure the temperature. This creates a safety hazard. When this happens, the unit goes into an alarm condition and turns off the heater and motor. To stop the alarm, fill the bath with oil (see page 5) and touch the alarm window. If a test was running, you will need to restart the heater and motor.



Onboard Display

Real-Time Data

The Real-Time Data screen is the default screen. When the display has been idle for more than 2 minutes, it will automatically revert to this screen. Here you can see the current test parameters. At the bottom of the screen is a series of buttons.

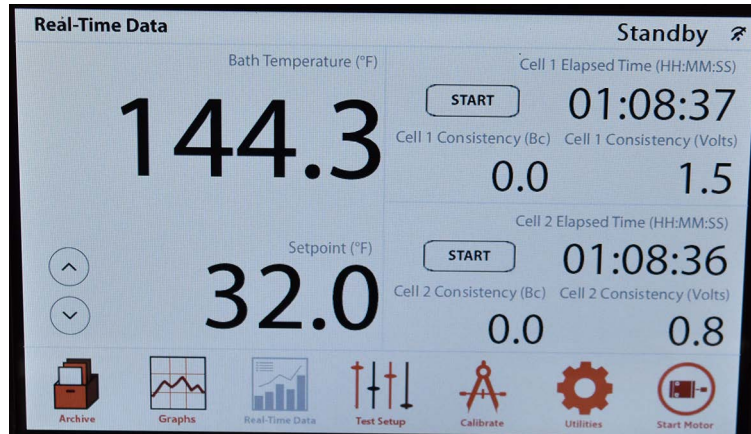

The **Real-Time Data** button returns you to the main screen, which shows the Bath Temperature, Temperature Setpoint, Consistency, and the two timers.

The **Test Setup** button takes you to the Test Setup screen where you can create advanced temperature profiles. See page 16 for more information.

The **Calibrate** button takes you to the Calibration screen where you can calibrate the Consistency. See page 15 for more information.

The **Utilities** button takes you to the Utilities screen where you can set the temperature units (°F or °C).

The **Start Motor** button starts the motor. Press the **Stop Motor** button to stop the motor.

The **Start Cooling** button opens the cooling valve and allows cooling water to circulate through the bath. Press **Stop Cooling** to close the valve and stop the flow of water. When Cooling is turned on, the Start Heating button is inactive.

The **Start Heating** button turns on the heater. Press the **Stop Heating** button to turn the heater off. When Heating is turned on, the Start Cooling button is inactive.

The **Archive** button takes you to the Archive screen where you can export test data to a USB drive.

Onboard Display

Utilities

On the Utilities screen you can adjust the date, time, sampling rate, and units.

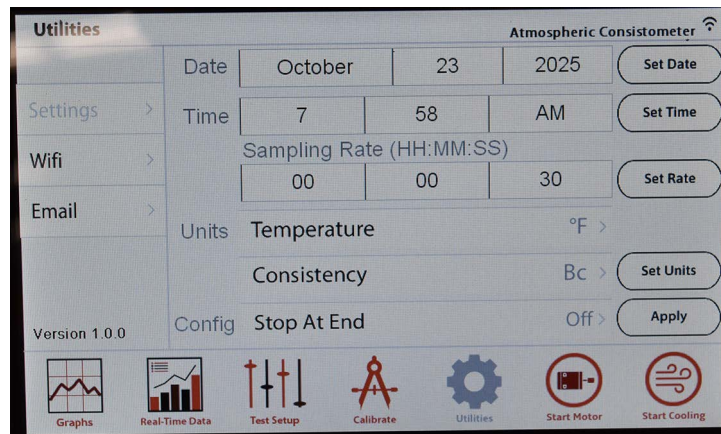

- Date:** Touch the month, day, and year fields and select the correct value. Then touch “Set Date”.
- Time:** Touch the hour, minute, and AM/PM fields and select the correct value. Then touch “Set Time”.
- Temperature:** Touch the units on the right to switch between °F and °C. Then touch “Set Units”.
- Consistency:** Touch the units on the right to switch between Bc and Volts. Then touch “Set Units”.
- Stop At End:** If Stop At End is turned on, when the programmed test is complete, the software will turn off the motor and heat. If this feature is turned off, at the end of the test the software will leave the motor on and maintain the last temperature setpoint indefinitely.
- Unit Name:** The Unit Name is in the top right-hand corner of the screen. If you have multiple units in your lab, you can touch the name and enter a new name to identify each unique unit.



Note

The Wifi and Email tabs on the left-hand side of the screen are for planned features. They do not have any function at this time.

Onboard Display

Archive

On the Archive screen you can export test data to a USB drive. The export files are named with the following format: CXMMDD##.csv, where X is the cell number (1 or 2), MM is the month, DD is the day, and ## is the number of the test for that day.

1. Place a USB drive in the port on the right-hand side of the instrument.

The port has an indicator light to show the status of the inserted drive:

- a. Green: The drive is inserted and supported.
 - b. Amber: The drive is inserted and supported, but low on free space.
 - c. Red: The drive is inserted but not supported. Make sure the drive is formatted in the FAT32 file system.
2. Choose the item to export.

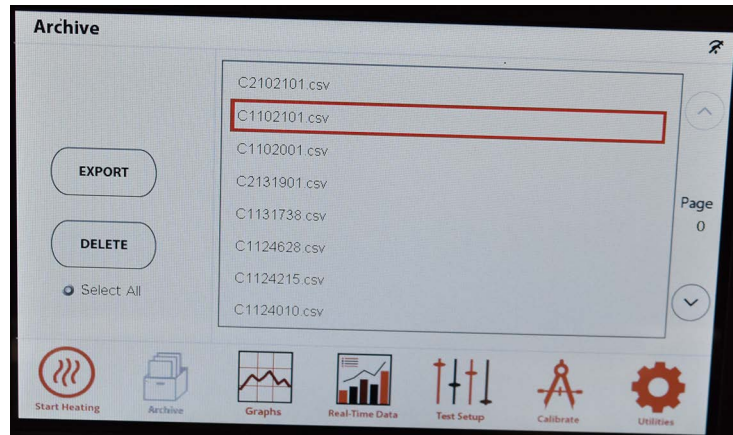

3. Select “Export”. The file will be saved to the USB drive.
4. To delete a single test, select the test and touch “Delete”.
5. To delete or export all tests, touch “Select All” then “Export” or “Delete”.

Onboard Display

Graphs

On the Graphs screen you will see a graph of the temperature and consistency over time. Touch the button in the upper left-hand corner to switch between Cell 1 and Cell 2.

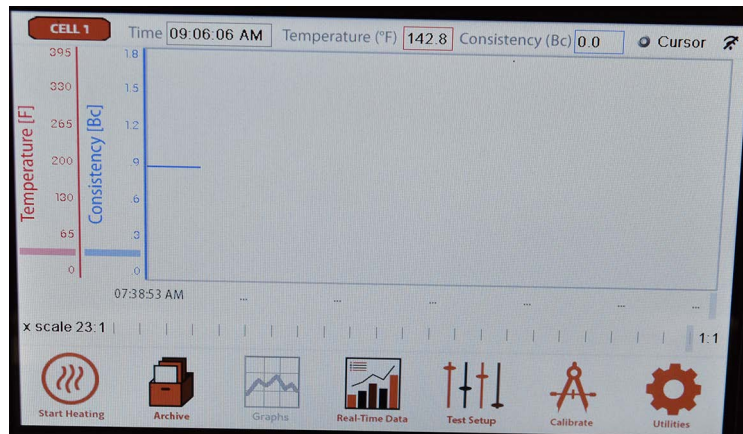

Operation

The Recording Atmospheric Consistometer performs two functions. It can be used to condition a cement slurry or to perform a thickening time test as detailed in API Specification 10.

1. Turn the “Power” switch on.
2. On the display, touch the temperature setpoint and enter the test temperature or use the up and down arrows to set the test temperature.



3. Load one or both test cells. Refer to “Setup - Loading the Test Cells” on page 7 for details.



Important

It is very important that you begin the test within one minute of mixing the cement slurry.

4. Touch the “Start Motor” button to start the motor.
5. For manual tests, touch the “Start Heating” button to start the heater.
6. On the “Test Timer 1” or “Test Timer 2” touch the hours, minutes, or seconds and enter the appropriate value to set the timer. When the timer counts down to zero, an alarm will sound.
7. Touch the “Start” button to start the timer.
8. When the test or conditioning is complete, touch the “Stop Motor”, “Stop Heating”, and “Start Cooling” buttons.



Important

If you are using water instead of oil in the bath, leave the Consistometer turned on until the temperature drops below 80°F (27°C) so that the fan can continue removing water vapor from the cabinet.

9. When the slurry containers are cool enough to handle, remove them from the unit and pour the cement slurry into the container for the intended test. Thoroughly clean the containers and paddle with soap and water. Be sure to remove any residual cement.

Calibration

Potentiometer

Calibrating the potentiometer allows the software to convert voltage to consistency. The optional Calibrator Assembly (#120-75-30) uses dead weight to simulate resistance on the potentiometer.

Before calibrating the potentiometer, test the container paddle for excessive friction by running the sample container empty. If the paddle is bent and rubbing on the side of the slurry container or if the bearings are damaged, excessive friction will show on the display (refer to page 18 for more information). Correct any defects before calibrating the potentiometer.

1. Place the potentiometer onto the calibration stand.
2. Plug the potentiometer into the port on the side of the cabinet.
3. Place the calibration ring around the potentiometer.
4. Wrap the deadweight calibration cord counterclockwise around the calibration ring and over the roller.

Make sure the potentiometer can turn freely. Orient the potentiometer so that the power cord does not interfere with its movement.

5. Place 50 g on the weight hanger and attach it to the calibration cord.

When adding weights, remember that the hook weighs 50 grams. Therefore, to test the potentiometer at 200 g, you only need to add 150 g to the hook.

6. On the touchscreen display, touch "Calibrate".
7. Follow the instructions on the screen.

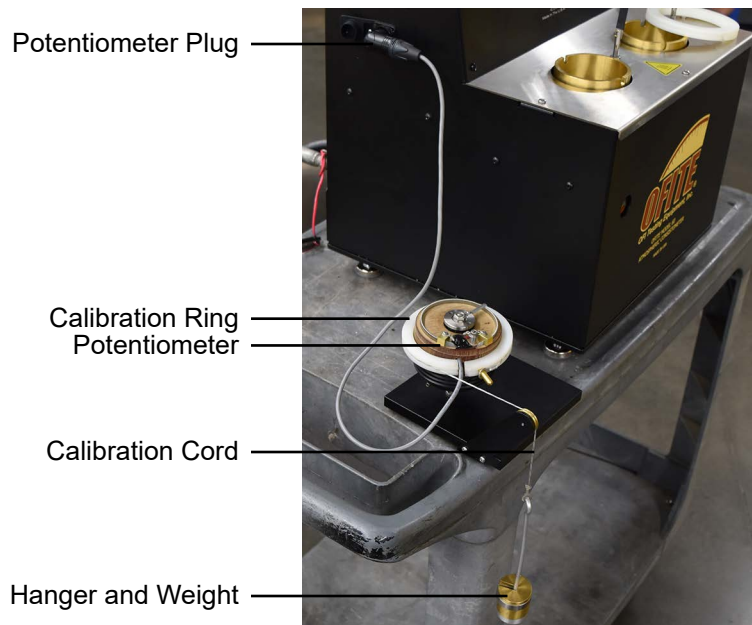

Calibration

Temperature Verification

1. Let the bath cool to ambient temperature.
2. Place one slurry container in the Atmospheric Consistometer and leave the other one out.
3. Start the motor.
4. Place a reference thermometer through the open hole and into the bath as close as possible to the thermocouple.
5. When the bath temperature has stabilized, compare the temperature reading on the screen to the reference thermometer.
6. Heat the bath to 190°F (88°C).
7. When the bath temperature has stabilized, compare the temperature reading on the screen to the reference thermometer.
8. If the reading on the screen is different from the reference thermometer, contact OFITE for calibration.

Calibration

Motor Speed

1. Remove the slurry containers.
2. Place a strip of reflective tape on the rotor.
3. Start the motor and use a laser tachometer to measure the speed of the rotor.
4. If the rotational speed is not $150 \text{ rpm} \pm 15$, loosen the three screws on the back panel of the unit and open the door.
5. To increase the rotational speed, turn the potentiometer speed control clockwise. Turn it counterclockwise to reduce the speed.



Potentiometer
Speed Control

Calibration

Timer

The timer should be accurate to within one second per 12 minutes. To verify the timer, start the timer at the same time as a certified timer and compare the two readings after 12 minutes.

Test Setup

The Recording Atmospheric Consistometer can be programmed with different temperature profiles.

1. Touch the “Test Setup” button.
2. Choose a profile and touch the “Edit” button.

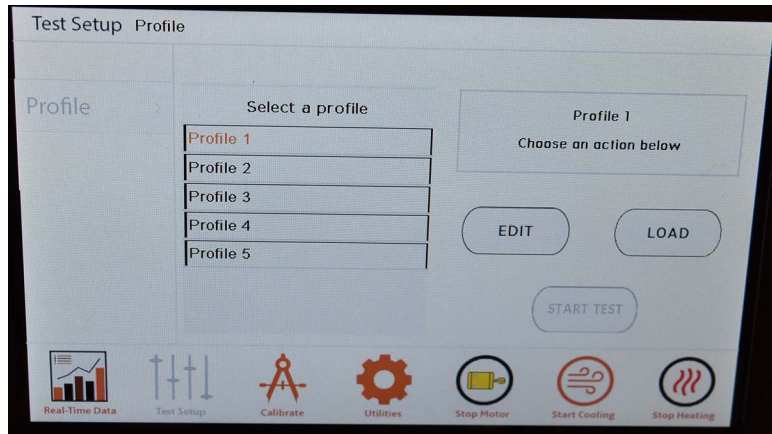

3. To change the name of the profile, touch the profile name above the step list. A keyboard will appear. Type the profile name and touch “Enter”.

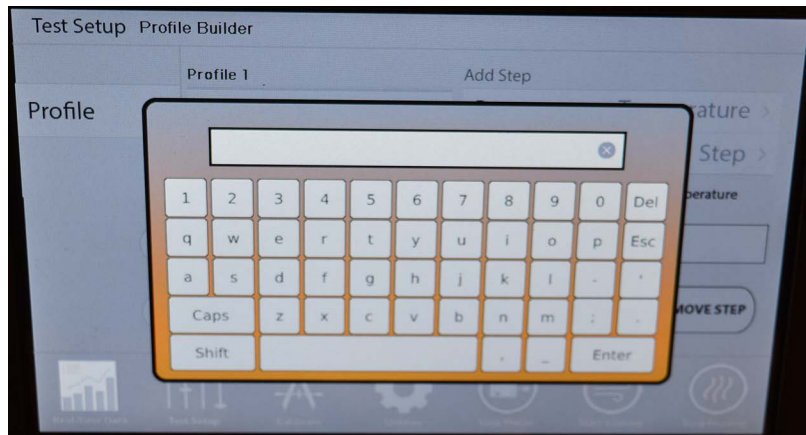



Important

4. Touch “Type” to choose between Ramp, Step, and Dwell:
 - **Ramp:** Change the temperature of the bath over a period of time.
 - **Step:** Change the temperature of the bath as fast as possible.
 - **Dwell:** Hold the current temperature for a specified period of time.

If the temperature setpoint is more than 10°F below the current temperature, the unit will give an alarm when the test is started. We recommend all steps in your test have setpoints above the starting temperature of the heating bath.

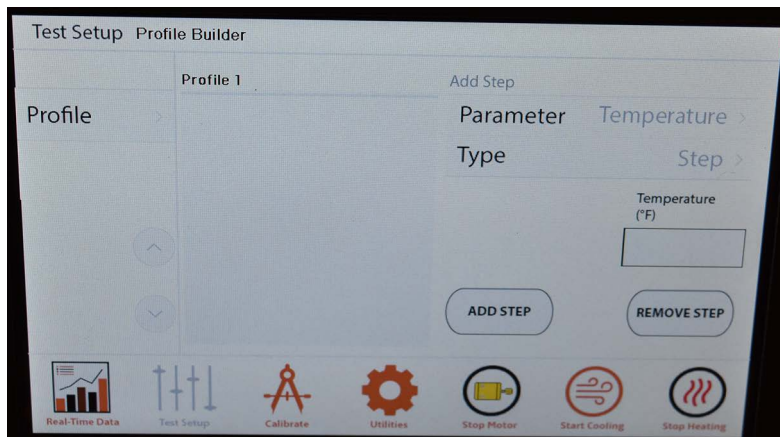

5. Touch “Add Step”.
6. Touch “Profile” to go back.
7. Touch “Load” to load the test profile into memory.
8. Touch “Start Test” to run the temperature profile. The display will return to the “Real-Time Data” screen.



Note

The timers on the “Real-Time Data” screen will be disabled while a test is running.

9. To stop the test, touch “Test Setup” and then “Stop Test”.

Maintenance

1. The belt and bearings that drive the rotators should be inspected annually. Disassemble the unit to access the bearings and belt:
 - a. Disconnect the unit from all electrical power.
 - b. Unscrew and remove the top protective cover plate.
 - c. Remove the screws on the Drive Plate and push it backward to loosen the belt.

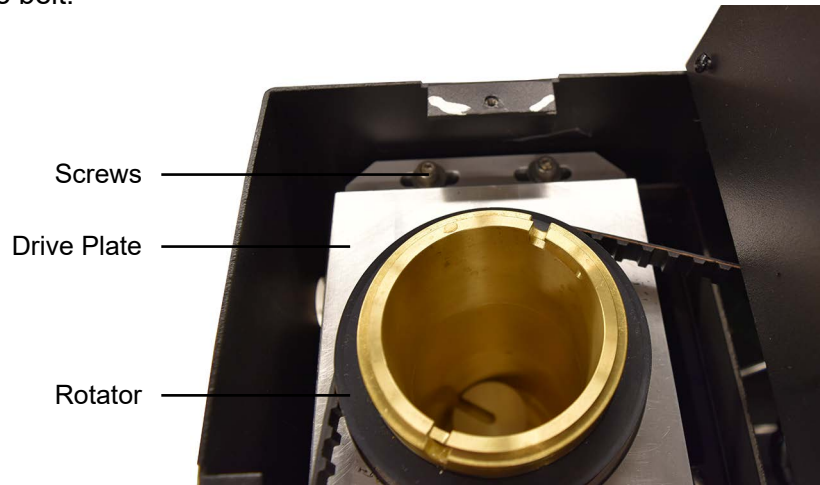

- d. Remove the belt from the Rotators.
- e. Lift the Drive Plate up and out.
- f. Remove the two Rotator from the Drive Plate.
- g. Examine the Main Bearings for damage and wear. Annually clean the bearings by lightly spraying them with WD-40.
- h. If they do not turn freely and smoothly, replace them with new bearings. Loosen the set screw on the front of the Drive Plate and remove the old bearing.

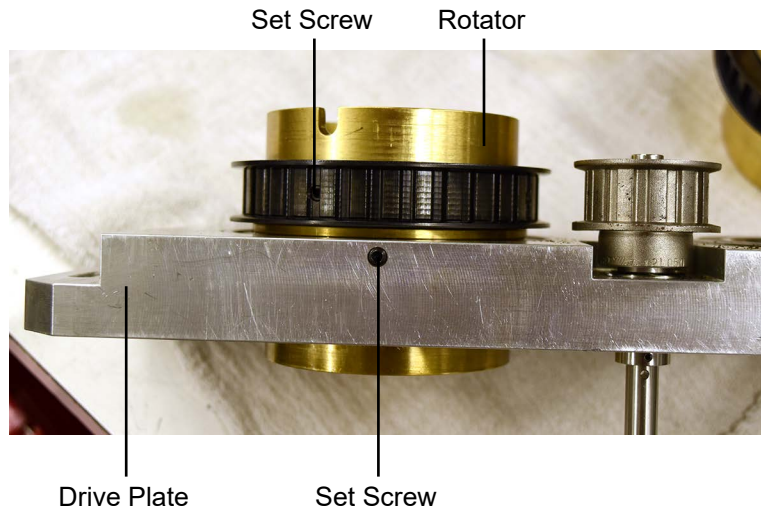

- i. Inspect the belt for damage or wear. If necessary, replace it with a new belt.
 - j. Re-assemble the unit, pushing the belt through the bath slot.
 - k. Pull the Drive Plate forward only enough to prevent belt slippage. Allow approximately $\frac{3}{4}$ " to 1" slack in the timing belt to prevent excessive side load to the bearings.
2. The bath should be checked and cleaned annually.
 - a. Access the bath housing as described in steps a through e on the previous page.
 - b. Visually inspect the mineral oil in the bath. If it contains any foreign material, pour out the entire contents and refill with clean mineral oil.
 3. Slurry containers and paddles should be kept as clean as possible. The lid should be thoroughly cleaned and any build up of cement should be removed.
 4. The Stop Pins next to the slurry cups are designed to break if the slurry gets too thick. This will protect the potentiometer from damage. If the stop pin breaks, it must be replaced before the next test.

Warranty and Return Policy

Warranty:

OFI Testing Equipment, Inc. (OFITE) warrants that the products shall be free from liens and defects in title, and shall conform in all respects to the terms of the sales order and the specifications applicable to the products. All products shall be furnished subject to OFITE's standard manufacturing variations and practices. Unless the warranty period is otherwise extended in writing, the following warranty shall apply: if, at any time prior to twelve (12) months from the date of invoice, the products, or any part thereof, do not conform to these warranties or to the specifications applicable thereto, and OFITE is so notified in writing upon discovery, OFITE shall promptly repair or replace the defective products. Notwithstanding the foregoing, OFITE's warranty obligations shall not extend to any use by the buyer of the products in conditions more severe than OFITE's recommendations, nor to any defects which were visually observable by the buyer but which are not promptly brought to OFITE's attention.

In the event that the buyer has purchased installation and commissioning services on applicable products, the above warranty shall extend for an additional period of twelve (12) months from the date of the original warranty expiration for such products.

In the event that OFITE is requested to provide customized research and development for the buyer, OFITE shall use its best efforts but makes no guarantees to the buyer that any products will be provided.

OFITE makes no other warranties or guarantees to the buyer, either express or implied, and the warranties provided in this clause shall be exclusive of any other warranties including ANY IMPLIED OR STATUTORY WARRANTIES OF FITNESS FOR PURPOSE, MERCHANTABILITY, AND OTHER STATUTORY REMEDIES WHICH ARE WAIVED.

This limited warranty does not cover any losses or damages that occur as a result of:

- Improper installation or maintenance of the products
- Misuse
- Neglect
- Adjustment by non-authorized sources
- Improper environment
- Excessive or inadequate heating or air conditioning or electrical power failures, surges, or other irregularities
- Equipment, products, or material not manufactured by OFITE
- Firmware or hardware that have been modified or altered by a third party
- Consumable parts (bearings, accessories, etc.)

Returns and Repairs:

Items being returned must be carefully packaged to prevent damage in shipment and insured against possible damage or loss. OFITE will not be responsible for equipment damaged due to insufficient packaging.

Any non-defective items returned to OFITE within ninety (90) days of invoice are subject to a 15% restocking fee. Items returned must be received by OFITE in original condition for it to be accepted. Reagents and special order items will not be accepted for return or refund.

OFITE employs experienced personnel to service and repair equipment manufactured by us, as well as other companies. To help expedite the repair process, please include a repair form with all equipment sent to OFITE for repair. Be sure to include your name, company name, phone number, email address, detailed description of work to be done, purchase order number, and a shipping address for returning the equipment. All repairs performed as "repair as needed" are subject to the ninety (90) day limited warranty. All "Certified Repairs" are subject to the twelve (12) month limited warranty.

Returns and potential warranty repairs require a Return Material Authorization (RMA) number. An RMA form is available from your sales or service representative.

Please ship all equipment (with the RMA number for returns or warranty repairs) to the following address:

OFI Testing Equipment, Inc.
Attn: Repair Department
11302 Steeplecrest Dr.
Houston, TX 77065
USA

OFITE also offers competitive service contracts for repairing and/or maintaining your lab equipment, including equipment from other manufacturers. For more information about our technical support and repair services, please contact techservice@ofite.com.