



Dependable Products From People You Trust



Model 800/800S Viscometer

- #130-10-C - Model 800 with Carrying Case
- #130-10-C-S - Model 800S with Carrying Case
- #130-10-L - Model 800 with Retractable Legs (For Kits)
- #130-10-L-S - Model 800S with Retractable Legs (For Kits)

Instruction Manual

Updated 3/4/2026

Ver. 16

OFI Testing Equipment, Inc.

11302 Steeplecrest Dr. · Houston, Texas · 77065 · U.S.A.

Tele: 832.320.7300 · Fax: 713.880.9886 · www.ofite.com

Table of Contents

Introduction.....	2
Description.....	2
Components	3
Specifications	5
Safety.....	8
Setup.....	11
Calibration.....	12
Operation.....	15
Calculations	17
Disassembly	17
Maintenance.....	18
Warranty and Return Policy	23

Introduction

The Model 800 and 800S 8-Speed Electronic Viscometers are designed and exclusively manufactured by OFI Testing Equipment, Inc. They are extensively used worldwide in both the field and laboratory for the precise measurement of rheological properties of fluids.

Description

The OFITE Model 800 and 800S Viscometers determine the flow characteristics of oils and drilling fluids in terms of shear rate and shear stress over various time and temperature ranges at atmospheric pressure. Speeds are easily changed with a control knob, and shear stress values are displayed on a lighted magnified dial for ease of reading.

The viscometer's motor RPM is continuously monitored and automatically adjusted to maintain a constant shear rate under varying input power and drilling fluid shear conditions. The eight precisely regulated test speeds (shear rates in RPM) are as follows: 3 (Gel), 6, 30, 60, 100, 200, 300, and 600. A higher stirring speed is also provided. Speeds may be changed with a control knob selection, without stopping the motor.

The Model 800 and 800S are suitable for both field and laboratory use and use a motor-driven electronic package to provide drilling fluid engineers with an extremely accurate and versatile tool. The Model 800 operates from a 13–16 VDC power source. The Model 800S operates from a 24VDC power source. The electronic regulator continuously monitors and automatically adjusts the rotational speed to maintain a constant shear rate under varying fluid shear conditions and input power variations that are commonly found on-site.

Components

#130-10-C Model 800 Viscometer

#130-10-2	Speed Reference PC Board
#130-10-3	Speed Control PC Board
#130-10-5	Switch Plate
#130-10-14	Motor
#130-10-16	Drive Belt
#130-10-23	Pulley for Motor
#130-10-30	Power Supply
#130-10-61	Light Assembly
#132-71	Bearing, 20 mm × 42 mm

#130-10-C-S Model 800S Viscometer

#130-00-501	Motor
#130-10-30-24	Power Supply
#130-10-60	Indicator Light
#130-11-5	Switch Plate
#130-11-006	Pulley for Motor
#130-11-501	Drive Belt
#130-11-506	Bearing, 20 mm × 42 mm

Both Viscometers:

#130-10-20	Torsion Shaft
#130-21	Cup, Stainless Steel
#132-50	Rotor Drive
#132-56	Rotor Sleeve, R1, 303 Stainless Steel
#132-57	Shield
#132-58	Bob, B1, 303 Stainless Steel
#132-59	Bearing Retainer
#132-74	Locking Ring, 1.653"
#132-75	Locking Ring, 1/2"
#132-76	Locking Ring, 25/32"
#134-05-2	Shielded Bearing for Bob Shaft
#134-10	Torsion Spring Assy, F1
#134-39	Clamp Sleeve for Torsion Spring
#134-40	Shim, 5/8" × 3/8"
#135-02	External Retainer Ring
#135-18	Socket Set Screw
#142-63	Locking Screw
#163-26	Small Clip
#170-21	Stand Support Rod
#170-44	Rubber Foot, 1/2"
#171-32	Midget Knob

Case:

#130-11-13-5	Carrying Case with Custom Foam Insert
--------------	---------------------------------------

Optional:

- #132-56-C R1 Closed-Cup Rotor; 316 Stainless Steel (For completion and fracturing fluid testing.)
- #130-45-1 Calibration Instrument (For 130-10-C and 130-10-L)
- #132-80 Calibration Fluid, Certified, 100 cP, 16 oz

Additional Bobs, Sleeves, and Springs:

- #132-58-1 B2 Bob, 303 Stainless Steel
- #132-58-2 B3 Bob, 303 Stainless Steel
- #132-58-3 B4 Bob, 303 Stainless Steel
- #132-58-4 B5 Bob, 303 Stainless Steel
- #132-58H B1 Bob, Hastelloy®
- #132-56H R1 Sleeve, Hastelloy®

- #134-10-2 F0.2 Torsion Spring Assembly (Green)
- #134-10-3 F0.5 Torsion Spring Assembly (Yellow)
- #134-10-4 F2.0 Torsion Spring Assembly (Red)
- #134-10-5 F3.0 Torsion Spring Assembly (Purple)
- #134-10-6 F4.0 Torsion Spring Assembly (White)

#130-10-SP One Year Spare Parts

- #130-10-18 Lens for Cover
- #130-10-503 Fuse, 4 Amp, Qty: 4
- #130-10-61 Light Assembly
- #132-59 Bearing Retainer
- #132-71 Bearing, Qty: 2
- #132-75 Locking Ring, ½"
- #132-80 Calibration Fluid, 100 cP, 16 oz
- #132-81 Calibration Fluid, 50 cP, 16 oz
- #134-05-2 Shielded Bearing for Bob Shaft, Qty: 4
- #134-10 Torsion Spring Assy, F1
- #135-02 External Retainer Ring, Qty: 2

Specifications

Instrument Geometry	True Couette Coaxial Cylinder
Speed Accuracy (RPM)	.1
Motor Speeds (RPM)	8 Fixed Speeds (600, 300, 200, 100, 60, 30, 6, and 3)
Readout	Direct Dial
Power Requirements	Model 800: 13 – 16 VDC Model 800S: 24VDC
Weight (kg)	6.0
Dimensions (cm)	15.2 × 17.8 × 40.6
Shipping Weight (kg)	20.4
Shipping Dimensions (cm)	55.9 × 25.4 × 40.6
Certifications	CE Certified

Range of Measurement

Rotor - Bob	R1B1	R1B2	R1B3	R1B4	R1B5
Rotor Radius, RR, (cm)	1.8415	1.8415	1.8415	1.8415	1.8415
Bob Radius, RB, (cm)	1.7245	1.2276	0.8622	0.8622	1.5987
Bob Height, L, (cm)	3.8	3.8	3.8	1.9	3.8
Shear Gap, (cm)	0.117	0.6139	0.9793	0.9793	0.2428
R Ratio, RB/RR	0.9365	0.666	0.468	0.468	0.8681
Shear Rate Constant k_R (sec ⁻¹ per RPM)	1.7023	0.377	0.2682	0.2682	0.8503
Shear Stress Constant for Effective Bob Surface k_S (cm ⁻³)	0.01323	0.02610	0.05290	0.10600	0.01541
Overall Instrument Constant, K, with Standard F1.0 Spring, $\eta = Kf\theta/N$	300	2,672	7,620	15,200	349

Max. Shear Stress, SS_{MAX} (Dyne / cm²)	Constant k_T	R1B1	R1B2	R1B3	R1B4	R1B5
F 0.2 (Green)	77.2	330	651	1,320	2,644	384
F 0.5 (Yellow)	193	840	1,657	3,359	6,730	977
F 1.0 (Blue)	386	1,680	3,314	6,717	13,460	1,955
F 2.0 (Red)	772	3,360	6,629	13,435	26,921	3,910
F 3.0 (Purple)	1,158	5,040	9,943	20,152	40,381	5,865
F 4.0 (White)	1,544	6,720	13,257	26,870	53,841	7,819
F 5.0 (Black)	1,930	840	16,571	33,587	67,302	9,774
F 10.0 (Orange)	3,860	16,800	33,143	67,175	134,603	19,548

Shear Rate Range	R1B1	R1B2	R1B3	R1B4	R1B5
Shear Rate Constant, K_R , (sec^{-1} per RPM)	1.7023	0.3770	0.2682	0.2682	0.8503
Shear Rate, (sec^{-1} or 1/s) 3 RPM	5.11	1.13	0.80	0.80	2.56
6 RPM	10.21	2.26	1.61	1.61	5.11
30 RPM	51.07	11.31	8.05	8.05	25.54
60 RPM	102.14	22.62	16.09	16.09	51.07
100 RPM	170.23	37.70	26.82	26.82	85.12
200 RPM	340.46	75.40	53.64	53.64	170.23
300 RPM	510.69	113.10	80.46	80.46	255.35
600 RPM	1021.38	226.20	160.92	160.92	510.69

Viscosity Ranges ^{<a>} (cP)	R1B1	R1B2	R1B3	R1B4	R1B5
Minimum Viscosity ^{} @600 RPM	0.5 ^{<c>}	4.5	12.7	25	1.2
Maximum Viscosity ^{<d>} @3 RPM	33,000	293,920	838,200	1,672,000	38,390

<a> Computed for standard Torsion Spring (F 1.0). For other torsion springs, multiply by F factor.
 Lower viscosities can be measured, however one must take into account the effect of bearing drag, Taylor vortices, zero offset, etc. when looking at the expected accuracy of the reading.
 <c> For practical purposes the minimum viscosity is limited to 0.5 cP due to Taylor Vortices.
 <d> Maximum viscosity is based on Maximum Shear Stress and Minimum shear rate (RPM). However, due to practical and physical limitations, it may be difficult to take these measurements.

Viscosity Conversions						
To convert from units on left side to units on top, multiply by factor @ intercept.						
	Centipoise (cP)	Poise (P)	$\text{g}/(\text{cm}^*\text{s})$	$(\text{mN}^*\text{s})\text{m}^2$	mPa^*s	$(\text{lbf}^*\text{s})/100 \text{ft}^2$
Centipoise (cP)	1	0.01	0.01	1	1	0.002088
Poise (P)	100	1	100	100	100	0.2088
$\text{g}/(\text{cm}^*\text{s})$	100	1	100	100	100	0.2088
$(\text{mN}^*\text{s})\text{m}^2$	1	0.01	0.01	1	1	0.002088
mPa^*s	1	0.01	0.01	1	1	0.002088
$(\text{lbf}^*\text{s})/100 \text{ft}^2$	478.93	4.789	4.789	478.93	478.93	1

Shear Stress Conversions					
To convert from units on left side to units on top, multiply by factor @ intercept.					
	Dyne/cm ²	Pa	lb/100ft ²	lb/ft ²	DR
Dyne/cm ²	1	0.1	0.2084	0.002084	0.1957
Pa	10	1	2.084	0.02084	1.957
lb/100ft ²	4.788	0.4788	1	0.01	0.939
lb/ft ²	478.8	47.88	100	1	93.9
DR	5.107	0.5107	1.065	0.01065	1

What Bob & Spring Should I Use?







There is often confusion or misunderstanding about what a viscometer can actually measure. For example, a viscometer with an R1 B1 F1 combination can measure water fairly well at 100 RPM and higher, but at 3 RPM, the readings would be shaky at best. While on the other hand, a linear fluid with a viscosity of 15,000, could not get past 6 RPM with the same combination.

To estimate which spring might be best, use the formula below to calculate a Minimum Spring factor, where one establishes the maximum RPM the fluid is going to be tested at, as well as what the expected "Apparent Viscosity" of the fluid at that RPM. If the Factor comes out as .87, then an F 1.0 spring should be used. If it comes out as .16, then an F 0.2 spring would be best. To cover all ranges, it may be necessary to use more than one spring.

$$\text{Minimum Spring Factor (F)} = \frac{\text{RPM(max)} * \text{AV(max)}}{\text{BOB(F)} * 90,000}$$

Bob (F)	
R1B1	1.0
R1B2	8.9
R1B3	25.4
R1B4	50.7
R1B5	2.4

Safety

Explanation of Symbols	
	<p>Caution: Risk of Danger - This symbol directs the operator to consult the instruction manual for safety related warnings. (ISO-7000-0434)</p> <p>Whenever this symbol is used on the equipment, the user must consult the manual to determine the nature of the hazard and any actions which have to be taken.</p>
	<p>Fuse: This is the internationally recognized symbol for a user-replaceable fuse. This symbol will be followed by information required to guide the user to choose the proper replacement fuse.</p>
	<p>Direct Current (DC): This symbol indicates an input (or output) that is direct current only. (IEC 60417-5013)</p>
 Note	<p>Note: This symbol will indicate important notes and helpful hints for the operation of the equipment.</p>
	<p>Polarity: This symbol indicates that the equipment receives positive voltage on the center pin of the connector and the return voltage is on the outer case.</p>
 Tip	<p>Tip: This symbol is used to identify operational information and best practices to obtain the most reliable data.</p>
	<p>Caution: Note - This symbol is used to indicate statements in the manual which warn against actions which may cause damage to the equipment during routine service or maintenance</p>



Electrical Requirements

The Model 800 and 800S Viscometers are powered by a DC power source. The power supply for the Model 800 (130-10-C) is capable of providing between 13 and 16 volts DC. The power supply for the Model 800S (130-10-C-S) supplies 24 volts DC. The equipment is current limited to 4 amps by a user-replaceable fuse. However, we suggest that the power supply be current limited to less than 4 amps to provide additional protection to the equipment.



Input Connector:
13 – 16 VDC Power
Inlet / Emergency
Disconnect Device

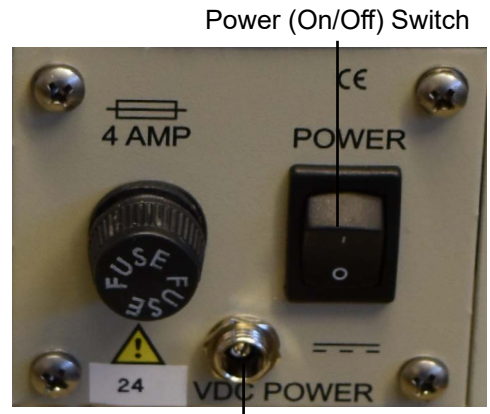

Input Connector:
24 VDC Power
Inlet / Emergency
Disconnect Device



When connecting the equipment to your power source, make sure that the power supply is connected to the center pin of the connector.



The equipment is supplied with a user-replaceable fuse. This fuse must only be replaced by a 250-volt, 4-amp, time-delayed fuse.

Environmental Conditions

The equipment is designed for use in normal environmental conditions:

- Indoors
- At or below an altitude of 2,000 m (6,562 ft)
- In temperatures between 5° and 40°C (41°–104°F)
- With a maximum relative humidity of 80% for temperatures up to 31°C (88°F) decreasing linearly to 50% relative humidity at 40°C (104°F)
- This equipment has not been rated according to IEC 60529



Note

Installation

The Model 800 and 800S Viscometers should be used in a location where they will not be subjected to excessive moisture. They should be placed on a flat, stable surface in a well-ventilated environment.



Caution – Risk of Danger: This equipment produces sound pressure in excess of 85 dBA. Protective measures (such as hearing protection, noise-reducing baffles, or a hood) should be considered.



Equipment Operation

Caution – Risk of Danger: The power cord and the DC inlet are the emergency disconnect devices. Do not position the equipment such that it is difficult to operate the emergency disconnect devices.



Caution – Risk of Danger: In normal operation, this equipment may liberate the potentially poisonous gasses listed below. However, the list below is dependent upon the chemical makeup of the sample fluids presented for testing. Care should be taken to ensure that: no unexpected or anomalous chemicals are contained or added to the test samples; the test environment is adequately ventilated; and, when necessary, appropriate personal protective equipment is employed.

- Hydrogen Sulfide (H²S)
- Methane (CH₄)
- Carbon Dioxide (CO₂)
- Sulfur Dioxide (SO₂)



Caution – Risk of Danger: The samples presented for testing may contain flammable substances. The following risk-reduction procedures must be followed to ensure the safe operation of the equipment.

- Always use in a well-ventilated area.
- Keep away from open flames.



Caution – Risk of Danger: If this equipment is operated in a manner not specified by the manufacturer (OFITE), the protections provided by the equipment may be impaired.



Caution – Risk of Danger: This equipment may operate unexpectedly if the equipment is energized when the Speed Selector Knob and Power (On/Off) Switch are left in the “On” position. Care should be taken to ensure both switches are in the “Off” position prior to energizing the equipment. Also, care should be taken to ensure that the Speed Selector Knob is in the “Off” position prior to turning the Power (On/Off) Switch to the “On” position.



Speed Selector Knob

Setup



The Viscometer is a precision instrument. Any damage to the bob shaft, bearings, or transducer will greatly affect the accuracy of the readings. Always handle the Viscometer with care, especially when installing and removing the bob.

Always remove the bob from the shaft before shipping the Viscometer. Failure to do so will damage the bob shaft.

1. Connect the instrument to a 13–16 VDC (for Model 800) or 24 VDC (for Model 800S), current-limited power source.
2. With the instrument turned off, place the splash guard onto the bob shaft with the tube end pointed up towards the bob. Push up.
3. Screw on the appropriate bob with the tapered end up towards the splash guard.
4. Place the sleeve onto the rotor over the bob. The threads assure the rotor will attach evenly and uniformly each and every time.
5. The power switch is located on the back panel. Turn the unit on.
6. Place a properly prepared sample of test fluid in a sample cup and immerse the rotor sleeve exactly to the fill line on the sleeve by raising the platform. Tighten the lock nut on the platform.

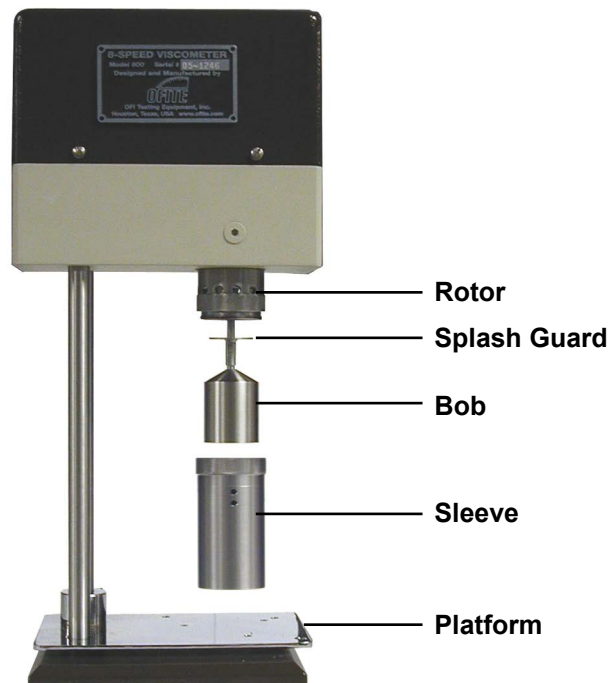

Calibration

The Model 800 and 800S Viscometers can lose calibration while in service if the bob shaft bearings become contaminated or if the bob shaft itself is bent. If the dial does not read zero when it should or if there is excessive dial deflection when the main shaft is turning, this may indicate that the bob shaft bearings are sticking. If the spring appears to be non-linear, the bob shaft may be bent. Your viscometer will require servicing if it exhibits any of these symptoms.

According to API Recommended Practice 10B-2, viscometers being used for testing well cement should be calibrated quarterly. API Recommended Practice 13B-1 and 13B-2 specify viscometers being used for drilling fluids should be checked monthly.

Certified Calibration Fluid

- #132-84 Calibration Fluid, 20 cP, 16 oz (500 mL)
- #132-81 Calibration Fluid, 50 cP, 16 oz (500 mL)
- #132-80 Calibration Fluid, 100 cP, 16 oz (500 mL)
- #132-83 Calibration Fluid, 200 cP, 16 oz (500 mL)
- #132-82 Calibration Fluid, 500 cP, 16 oz (500 mL)

Procedure:

1. Choose the certified calibration fluid using the temperature-viscosity chart supplied with the calibration fluid to cover the viscosity range of interest. Make sure the lot number on the chart matches the lot number on the fluid container. Each lot of standard fluid is individually certified. The viscosity will normally vary slightly from lot to lot.
2. Clean and dry the viscometer bob, sleeve, and cup. Place the viscometer and the calibration fluid side-by-side on the counter top in a room with a reasonably constant temperature (variation of less than $5^{\circ}\text{F} \pm 2.5^{\circ}\text{F}$). Allow the viscometer and the fluid to stand at least two hours to equilibrate.
3. Operate the viscometer in air for two to four minutes to loosen up the bearings and gears. Observe the rotor sleeve for excessive wobbling and replace if necessary.
4. Fill the cup to the scribed line with calibration fluid and place it on the viscometer stage. Move the stage upward until the fluid level is to the fill line on the sleeve.



Never immerse the sleeve in fluids above the fill line.

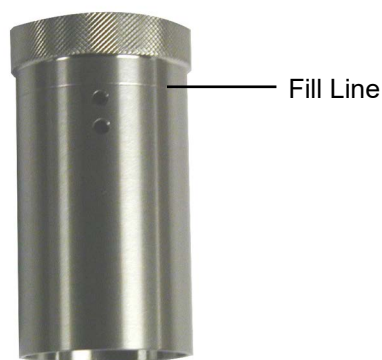

Viscometer Sleeve

5. Place a thermometer capable of $\pm 0.2^{\circ}\text{F}$ (0.1°C) into the fluid and hold or tape it in place to prevent breakage. Operate the viscometer at a low speed setting until the thermometer reading becomes stable to within $\pm 0.2^{\circ}\text{F}$ (0.1°C) per 30 seconds. Note and record the temperature reading.
6. Once the temperature has stabilized, operate the viscometer at 600 RPM and then at 300 RPM. Note and record the dial readings to the nearest 0.5 dial unit.

7. Using the temperature-viscosity chart supplied with the calibration fluid, determine the certified viscosity to the nearest 0.5 centipoise.
 - a. Compare the 300 RPM reading to standard viscosity and record the deviation plus or minus.
 - b. Divide the 600 RPM dial reading by 1.98, compare that to standard viscosity, and record the deviation plus or minus.
8. Deviations exceeding 1.5 dial units are not acceptable. If the deviation exceeds this tolerance, the viscometer will require adjustments or calibration by a qualified technician.
9. Record the viscometer serial number, date, and deviation. Mark on the viscometer the date of calibration and a general indication of the calibration check status.

Operation

Measuring Viscosity:

1. Mix the sample on the “STIR” setting for 10 seconds while heating or cooling the fluid. Monitor the temperature with a thermometer. Continue to mix until the sample reaches the target temperature.
2. Rotate the knob to one of the speed settings. When the dial reading stabilizes, record the reading and the temperature. Repeat this step for any other speeds that your test requires.

Always start with the higher RPM and work your way down to the lowest RPM. For example, if you need readings at 100 RPM, 200 RPM, and 300 RPM, record the measurement at 300 RPM first, then 200 RPM, then 100 RPM, then gel strengths (if necessary).



Tip

Measuring Gel Strength:

1. Mix the sample on the “STIR” setting for 10 seconds.
2. Rotate the knob to “GEL” and immediately shut off the power.
3. As soon as the sleeve stops rotating, wait 10 seconds and turn the power back on while looking at the dial. Record the *maximum* dial deflection before the gel breaks. This is the 10 second gel strength.

When measuring gel properties, the dial does not have to return to zero during the quiescent period. Therefore, it should not be forced back to the zero setting if it does not freely do so. When determining the maximum dial deflection, no allowance needs to be made if the dial did not start at zero. Only the maximum dial deflection is of interest. Rheological properties and characteristics of the sample will determine if the dial returns to zero during the quiescent periods of the gel measurements.



Note

4. For the 10 minute gel strength, re-stir the fluid and wait 10 minutes before recording the *maximum* dial deflection.

API Testing

1. Mix the sample on the “STIR” setting for 10 seconds.
2. Set the speed to 600 RPM. Wait for the reading to stabilize and then record the dial reading and temperature.
3. Set the speed to 300 RPM. Wait for the reading to stabilize and then record the dial reading and temperature.
4. Stir the sample again for 10 seconds.
5. Set the speed to “GEL” and immediately shut off the power.
6. As soon as the sleeve stops rotating, wait 10 seconds and turn the power on while looking at the dial. Record the *maximum* dial deflection before the gel breaks. This is the 10 second gel strength.
7. For the 10 minute gel strength, re-stir the fluid and wait 10 minutes before recording the *maximum* dial deflection.

Calculations

- Plastic Viscosity (PV), cP = 600 RPM reading – 300 RPM reading
- Yield Point (YP), lb./100 ft² = 300 RPM reading – Plastic Viscosity (PV)
- Apparent Viscosity (AV), cP = 600 RPM reading / 2
- Gel Strength, 10 second, lb/100 ft² = the maximum dial deflection after 10 sec.
- Gel Strength, 10 minute, lb/100 ft² = the maximum dial deflection after 10 min.

$$\eta = K F \frac{\Theta}{\text{RPM}}$$

η = Viscosity (cP)

K = Machine constant for the bob and rotor combination

F = Spring factor

Θ = Dial readings

RPM = Rotational speed

Machine constants:

R1B1 = 300

R1B2 = 2,672

R1B3 = 7,620

R1B4 = 15,200

R1B5 = 349

Disassembly

Clean the viscometer after every test.

1. Remove the sleeve from the rotor.
2. Remove the bob.
3. Once the bob is removed, remove the splash guard and wipe down the bob shaft. Clean all removed parts with soap and water and dry them thoroughly.



Keep the instrument upright at all times, especially when cleaning so that water does not get into the bearings.

Maintenance

From time to time, the bearings will need to be changed. Complete the following to determine if it is time to perform this maintenance procedure:

1. The viscometer should have a zero dial reading when placed in an upright position with the sleeve not immersed in fluid prior to running tests.
2. With the instrument in this position, rotate the sleeve at 600 RPM. The dial reading in air should not exceed one.
3. Place water in a suitable container and immerse the rotor sleeve to the fill line.
4. Rotate the sleeve at 600 RPM. The dial reading in water should be between 1.5 and 3.0.
5. At 300 RPM, the dial reading in water should be between 0.5 and 2.0.

If the viscometer fails to pass any one of the above tests, the bearings are bad and should be replaced by a qualified instrument technician.

Bob Shaft Bearing and Torsion Spring Replacement:

Tools Required:

Allen Wrench, $\frac{1}{16}$ "
Phillips Head Screwdriver
Retainer Ring Pliers (small)
External Retainer Ring Pliers
Flat Screw Driver
Bob Shaft Wrench

Replacement Parts:

#134-05-2 Bearing for Bob Shaft, Shielded

1. Unplug the power supply and remove the sleeve and bob.

Use the bob shaft wrench to hold the shaft in place while unscrewing the bob.

2. With the flat-head screw driver, loosen the set screw in the speed control knob. Remove the speed control knob from the unit.
3. Remove all four flat-head screws on the outer housing cover and gently lift the cover upward.
4. Loosen the set screw at the top of the Zero Calibration Knob one turn counterclockwise.



5. Loosen the two screws in the top of the Index Block. Pull the Index Block straight back to prevent damage to the dial or stop pin.
6. Loosen the top set screw on the dial one turn counterclockwise.
7. Gently lift the torsion spring straight up.



Do not stretch the torsion spring.

If you are replacing only the torsion spring, discard the old spring, and skip to step 21 to complete the process.

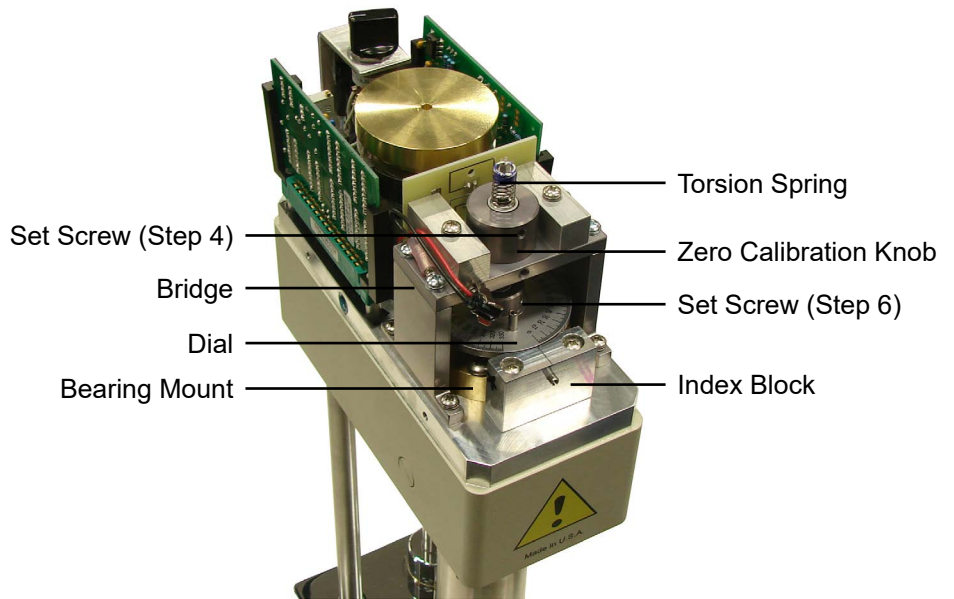

Model 800

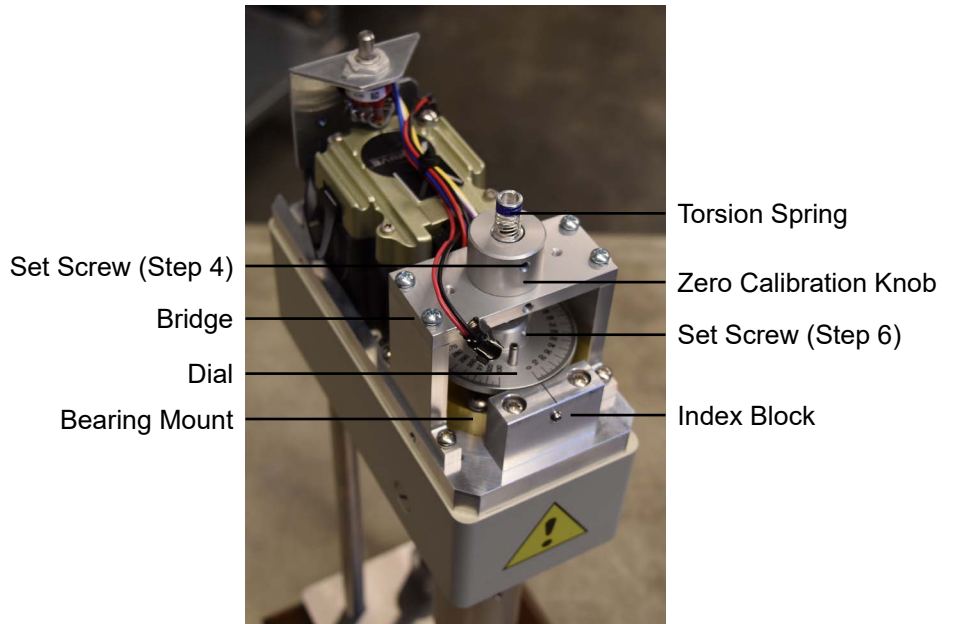

Model 800S

8. Remove the four screws from the bridge, disconnect the light, and lay the bridge gently to the side.



Do not touch the encoder that encircles the flywheel.

9. While holding the bob shaft with the bob shaft wrench, loosen the set screw (one turn counterclockwise) on the bottom of the dial. Remove the bob shaft by pulling it straight down.
10. Remove the two screws on the bearing mount and pull it straight up to remove it.



Be careful not to damage the pins.

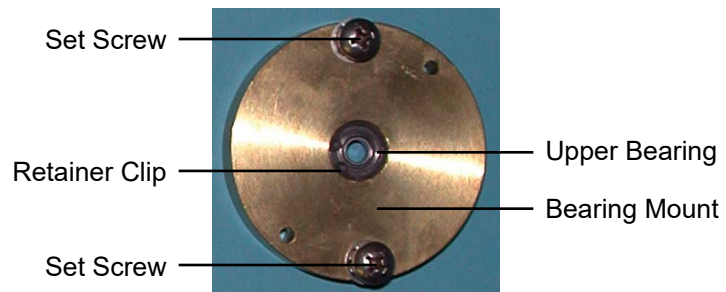

11. The upper bearing is located inside the bearing mount. Use retaining ring pliers to remove the retainer ring. Push the bearing upwards to remove it from the bearing mount.
12. Use surgical gloves to insert a new upper bearing into the bearing mount. Gently push downward to seat the bearing. Replace the retainer ring with the retaining ring pliers.



Do not touch the bearing with bare hands. Dirt, oils, and other contaminants can damage the bearing.

13. Slide the bearing mount back onto the two pins and tighten the two screws.
14. Remove the Splash Guard by sliding it straight down the shaft.
15. Loosen the set screw on the bearing shield (one turn counterclockwise). Slide the bearing and bearing shield off the bob shaft.
16. Use surgical gloves to slide a new lower bearing onto the bob shaft.



Note

- Slide the bearing shield back onto the bob shaft and tighten the set screw. Slide the splash guard onto the bob shaft until it touches the bearing shield.

The bearing should be able to free spin for up to two minutes. If it does not, replace it with a new bearing.

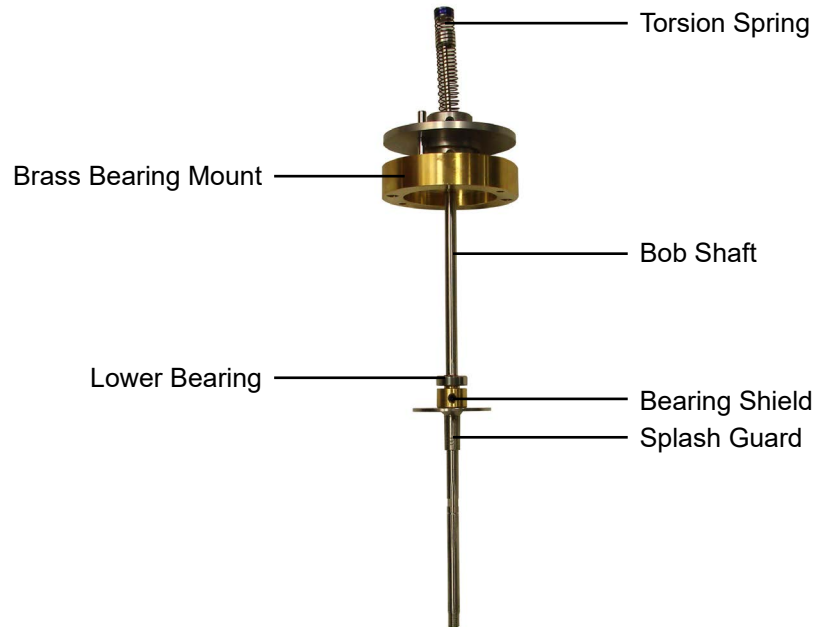

- Slide the bob shaft up through the bearing mount. Turn the bob shaft until the flat portion is facing the front of the unit.
- Align the bottom set screw on the dial with the flat portion of the bob shaft and tighten firmly. Make sure the set screws are perpendicular to the top of the bob shaft.



Note

The bob shaft should rotate smoothly without any noise.

- Replace the bridge being careful not to touch or bend the encoder. Tighten the four screws. Re-attach the light.
- Gently slide the torsion spring through the Zero Calibration Knob and into the dial. Make sure the bottom of the torsion spring is seated properly inside the dial. Tighten the set screw at the top of the dial to secure the torsion spring.
- Slide the index block into place. Tighten the two screws. Make sure the zero mark on the dial is aligned with the mark on the index block.

23. Press down on the torsion spring until the internal ring is flush with the Zero Knob and tighten the set screw.
24. Loosen the set screw on the bridge on turn counterclockwise. Adjust the Zero Calibration Knob so that the zero on the dial lines up with the line on the index block. Tighten the set screw.
25. Replace the bob and sleeve.
26. Re-attach the main housing cover.
27. Re-attached the speed control knob.
28. Re-calibrate the instrument.

Warranty and Return Policy

Warranty:

OFI Testing Equipment, Inc. (OFITE) warrants that the products shall be free from liens and defects in title, and shall conform in all respects to the terms of the sales order and the specifications applicable to the products. All products shall be furnished subject to OFITE's standard manufacturing variations and practices. Unless the warranty period is otherwise extended in writing, the following warranty shall apply: if, at any time prior to twelve (12) months from the date of invoice, the products, or any part thereof, do not conform to these warranties or to the specifications applicable thereto, and OFITE is so notified in writing upon discovery, OFITE shall promptly repair or replace the defective products. Notwithstanding the foregoing, OFITE's warranty obligations shall not extend to any use by the buyer of the products in conditions more severe than OFITE's recommendations, nor to any defects which were visually observable by the buyer but which are not promptly brought to OFITE's attention.

In the event that the buyer has purchased installation and commissioning services on applicable products, the above warranty shall extend for an additional period of twelve (12) months from the date of the original warranty expiration for such products.

In the event that OFITE is requested to provide customized research and development for the buyer, OFITE shall use its best efforts but makes no guarantees to the buyer that any products will be provided.

OFITE makes no other warranties or guarantees to the buyer, either express or implied, and the warranties provided in this clause shall be exclusive of any other warranties including ANY IMPLIED OR STATUTORY WARRANTIES OF FITNESS FOR PURPOSE, MERCHANTABILITY, AND OTHER STATUTORY REMEDIES WHICH ARE WAIVED.

This limited warranty does not cover any losses or damages that occur as a result of:

- Improper installation or maintenance of the products
- Misuse
- Neglect
- Adjustment by non-authorized sources
- Improper environment
- Excessive or inadequate heating or air conditioning or electrical power failures, surges, or other irregularities
- Equipment, products, or material not manufactured by OFITE
- Firmware or hardware that have been modified or altered by a third party
- Consumable parts (bearings, accessories, etc.)

Returns and Repairs:

Items being returned must be carefully packaged to prevent damage in shipment and insured against possible damage or loss. OFITE will not be responsible for equipment damaged due to insufficient packaging.

Any non-defective items returned to OFITE within ninety (90) days of invoice are subject to a 15% restocking fee. Items returned must be received by OFITE in original condition for it to be accepted. Reagents and special order items will not be accepted for return or refund.

OFITE employs experienced personnel to service and repair equipment manufactured by us, as well as other companies. To help expedite the repair process, please include a repair form with all equipment sent to OFITE for repair. Be sure to include your name, company name, phone number, email address, detailed description of work to be done, purchase order number, and a shipping address for returning the equipment. All repairs performed as "repair as needed" are subject to the ninety (90) day limited warranty. All "Certified Repairs" are subject to the twelve (12) month limited warranty.

Returns and potential warranty repairs require a Return Material Authorization (RMA) number. An RMA form is available from your sales or service representative.

Please ship all equipment (with the RMA number for returns or warranty repairs) to the following address:

OFI Testing Equipment, Inc.
Attn: Repair Department
11302 Steeplecrest Dr.
Houston, TX 77065
USA

OFITE also offers competitive service contracts for repairing and/or maintaining your lab equipment, including equipment from other manufacturers. For more information about our technical support and repair services, please contact techservice@ofite.com.